

INTRODUCTION

What is Screen Printing?

Artists call it serigraphy, hobbyist call it silk screen printing

Seeking a challenging and creative career?

The screen printing industry today is a large and highly varied industry in North America, and offers many exciting opportunities for a motivated individual.

Thousands of people are employed in this business and it involves literally billions of dollars.

Screen printing is ancient, yet a highly revolutionary industry.

Screen printing is one of the world's oldest methods of printing words and images. Its origin can be traced back to early Egyptian and Chinese civilizations. Although it is an ancient process, there have been many new innovations and improvements in the last decades. Glow in the dark and scented inks, dye discharge for printing on darks, environmentally friendly and extremely high quality water based inks. Not to mention computer artwork!

Print on virtually anything.

Today it is still the only printing method that allows you to print directly onto virtually anything, including vertical, soft, hard, or round surfaces. Where other methods fail, screen printing often offers the solution.

Screen printing is universal - you see it everywhere.

With all the new processes and advancements, we come in contact with screen printed materials everyday, everywhere. For example, most of the plastic containers used for cosmetics, food, and industrial products, billboards, supermarket signs, ball point pens, golf balls, T-shirts, caps, safety stickers and product identification decals, imprinted toys, decorative automobile trim and truck signs have all been screen printed.

Even electronic circuit boards and screen printed with special conductive inks allowing speedier production and cost reduction.

Screen printing is simple.

- (1) A screen fabric or mesh (similar to a window screen, but much finer) is stretched tightly onto a square or rectangular frame. The screen fabric may be silk, nylon, wire, cotton organdy, but usually polyester.
- (2) Part of the screen is blocked with a stencil.
- (3) When ink is deposited onto the screen and frame assembly, pressure is required to spread and push the ink through those areas for the screen that are not blocked by the stencil. This is accomplished by the use for a squeegee-a flexible plastic or rubber blade supported by a holder.
- (4) When the ink passes through to the surface below, that surface (called the substrate) is printed with the image defined by the stencil. The substrate may be T-shirts, paper, glass, plastic, or any of numerous possibilities.

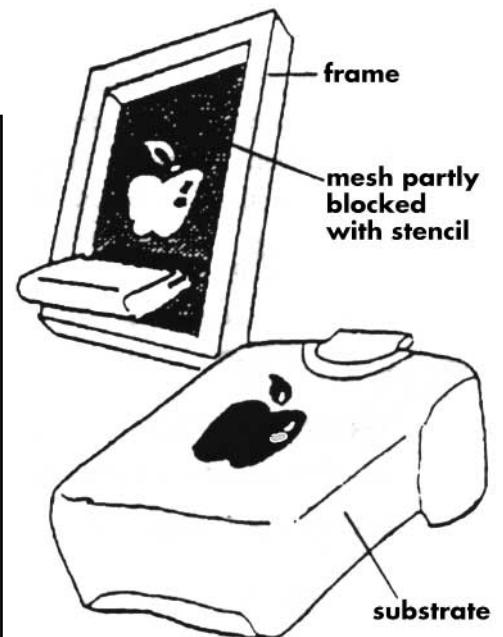

SCREEN PRINT MATERIALS

FRAMES

Frames may be of wood, metal, or our new environmentally friendly frames of recycled plastic (Enviro Frames). These are light weight, easy to clean and easy to lock into hinge clamps, will not soak up water, rot, or warp. You can buy the frames made to measure, or, in the case of wood, construct them yourself from pre-cut lengths.

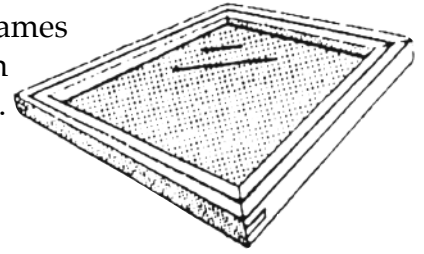

SCREEN MESH

Silk was the original material used, hence the name "silk screening", but it is rarely used today in the industry. Multifilament and monofilament polyester are the products used, monofilament being the most popular.



Multifilament Polyester mesh is made from twisted strands of polyester



Monofilament Polyester mesh is made from single strands of polyester.

Mesh count is denoted by a number, which increases with the fineness of the mesh. A mesh count for monofilament for 160 means there are 160 openings per inch.

Monofilament meshes commonly used by textile screen printers are as follows:

60-110	Puff plastisol direct prints.
86-305	General direct printing with plastisol inks.
160-305	Finer detail and halftone printing with plastisol inks.
109-200	Direct printing using Aquatex water-based inks.
200-305	Printing decals and crests with multi-plastic solvent based-inks.

Multifilament mesh comes in counts 6XX to 16XX, again the higher number being the finer mesh. The meshes most commonly used for printing Aquatex water based inks are 8XX-16XX.

For a mesh comparison chart of multi-and monofilament meshes, as well as description and technical data for mesh counts and inks.

SCREEN PREP TAPE

This plastic tape is applied around the outer edges of the screen, making clean-up much easier.

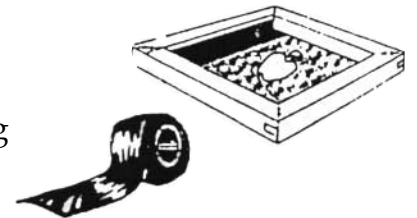

XR BLOCKOUT - This compound is ideal for touching up pinholes or register marks. Brushes on with a cotton swab or brush.

ARTIST'S KNIFE - An essential tool for cutting masking film.



AMBER MASKING FILM - Used for artwork preparation and for hand-cutting positives. Easy stripping and very opaque.

AUTOPREP - A grey paste containing abrasive ideal for preparing mesh to receive the stencil film. Since the mesh material is chemically inert, the adhesion is physical. To increase this adhesion, the mesh must be roughened with Autoprep.

STENCIL SYSTEMS

CAPILLEX FILM (PRE-SENSITIZED PHOTO STENCILS)

The latest in stencil making! This is a light-sensitive photo-stencil film (a pre-sensitized factory-coated emulsion on a film base support) used to create screen printing stencils. The capillary film is applied directly to the screen, dried, and then exposed to UV light with a positive.

How It Works: The film will harden when exposed to the UV light. The positive, being opaque, will prevent some of the areas of the film from being exposed and will remain soft. After exposure, the stencil is washed with water and the soft unexposed areas which were blocked by the positive will be open, leaving you the negative image of the positive on the screen.

DIRECT EMULSION - A sensitized emulsion is coated onto the mesh, generally using a scoop coated, and then dried before exposing to UV light with a positive.

Brand names - Duracoat, Resistal, Autosol Fast, Autosol Plus Clear

INDIRECT PHOTO STENCIL FILMS - A photo sensitive film that is exposed to UV light, washed out, developed, and then applied to the screen mesh. The carrier sheet is peeled after drying the film, and then used to print. Brand names - Five Star, Nova Star

HANDCUT STENCIL FILMS - Films that are cut by knife rather than by UV light.

Brand names - Autotype Solvent Green, Autotype Autocut Amber

TRANSFER PAPERS - Specially designed papers for screen printing with the "Heat Transfer" method. The image is screen printed as a reverse image onto the paper, placed image down on the substrate, and then heat is applied with a heat transfer machine. Brand names - Duo Trans II, Aqua Trans, Soft Trans ST88 Hot Peel, Transfer-75 and Copy Trans which has been developed as a instant heat transfer paper.

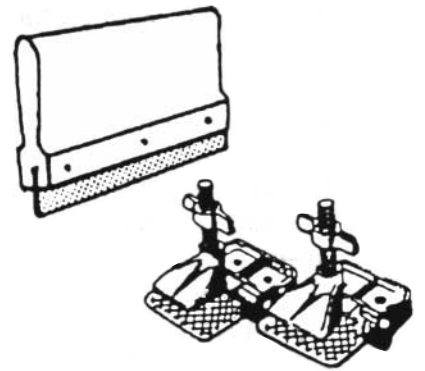

SQUEEGEES - A basic piece of equipment (rubberlike blade in a handle) used for flooding the screen with the ink and printing. Blades have varying degrees of hardness (durometer) for different printing jobs.

HINGE CLAMPS - Features a wide-wing thumb screw for firm and easy fastening to the screen frame. Easy to install, the clamp offers positive locking for perfect registry and precise control.

SPRAY ADHESIVE - Apply to clean printing table to keep textile or paper in place and wrinkle-free during printing. Will not stain fabric.

2000 GREEN - An excellent biodegradable, environmentally safe wash-up for plastisols and water-based inks. Also removes adhesives, tar, grease, and other grime.

SCREEN STRIP - Mixes with water to form a solution which removes the stencil after printing.

G&S PIGMENT SYSTEM

This system is a very simple to use (mix your own) fabric paint. It consists of a neutral BASE and 20 colour pigments. The pigment colours are added to the base to produce brilliant colours. Fixation is by heat, either in 150°C oven or with an iron.

Information Sheets Available:
detailed explanation of components

COLOUR CHART - #207

\$3.00

		<u>1 Quart</u>	<u>2 Quarts</u>	<u>5 Gallons</u>	<u>30 Gallons</u>
Base		\$8.00	\$14.00	\$100.00	\$500.00
Opaque Base		\$20.00	\$35.00	\$200.00	
		<u>30 mL</u>	<u>120 mL</u>	<u>250 mL</u>	<u>1 Litre</u>
110	Bright Yellow	\$3.00	\$7.95	\$14.25	\$42.75
120	Process Yellow	\$3.00	\$7.95	\$14.25	\$42.75
130	Golden Yellow	\$3.75	\$11.10	\$20.70	\$62.10
210	Warm Red	\$3.70	\$10.35	\$19.50	\$58.50
220	Cardinal Red	\$4.70	\$14.95	\$28.75	\$86.25
230	Rhodamine Red	\$4.65	\$14.90	\$28.55	\$85.65
240	Rubine Red	\$4.50	\$14.00	\$26.95	\$80.85
250	Process Magenta	\$4.20	\$12.55	\$23.10	\$69.30
320	Violet	\$4.70	\$14.95	\$28.75	\$86.25
410	Process Blue	\$4.05	\$13.00	\$24.65	\$73.95
420	Royal Blue	\$4.70	\$14.95	\$28.75	\$86.25
440	Navy Blue	\$4.25	\$13.85	\$26.00	\$71.50
500	Green	\$3.95	\$12.50	\$21.40	\$64.20
600	Brown	\$3.00	\$7.95	\$14.25	\$42.75
720	Black 3X	\$3.55	\$8.70	\$15.85	\$47.55
750	White	\$2.90	\$7.35	\$13.15	\$39.45
810	Fluorescent Pink	\$3.25	\$9.65	\$18.00	\$54.00
820	Fluorescent Yellow	\$4.00	\$12.55	\$23.80	\$71.40
910	Anti-Bleed	\$2.90	\$5.60	\$10.50	\$32.50
920	Resfix	\$3.00	\$5.80	\$10.95	\$32.85
930	Softener	\$3.00	\$5.80	\$10.95	\$32.85
940	Ink Retarder	\$3.00	\$5.80	\$10.95	\$32.85

Essential Components

BASE

The base is a thickened medium, resembling yogurt to which you add the pigment colour. It is the correct consistency for painting or screen printing. This base prints clear until you add colour.

Opaque base is a premixed white ink for printing on dark colours.

PIGMENT

The pigment is concentrated pure colour. Different shades of colour are achieved by varying the quantity of pigment added to the base (30mL makes approx. $\frac{2}{3}$ quart of paint - medium intensity). Colours are mixable!

White pigment is added to your mixed colours to make them opaque. Opaque white acts like an optical brightener making a colour appear clearer and stronger.

RESFIX

Clear liquid ingredient which improves wash fastness and crocking properties (rubbing off). Mix Resfix into the base when adding pigment colour, in the ratio of 5mL (1 tsp) per 500mL.

ANTI-BLEED

Added to the base to stop bleeding. Bleeding should only occur when the ink is too watery or when using synthetic fabric.

SOFTENER

Extremely helpful when printing soft objects that are flexible. ie. Terry cloth towels. Use at a 5% solution.

INK RETARDER

It is used to slow down the drying time of inks in the screen. Essential for Opaque Base.

CREATING ARTWORK

The first step in the creation of a screen printed object is the creation of artwork to be used for your design.

Because the stencil method you will use later to prepare your screen is photographic, you must first make a positive.

A POSITIVE is a design (words and/or images) on a transparent or translucent material. The positive will then be used to burn the image onto the stencil material.

FOR EACH COLOUR A SEPARATE POSITIVE IS REQUIRED.



A positive may be made by hand, by camera, by computer, or by copier machine.

A) CREATING A POSITIVE BY COMPUTER: The latest technology in computer software allows creations of artwork with ease and precision unrivaled. Many choices of print type and the ability to arrange it however desired, saves hours of work. Pictures can be scanned into the computer and transformed to your specifications, or you may use "clip art" from the program. The different colour jobs can be printed a such right onto X200 positive paper, ready to be exposed.

B) CREATING A POSITIVE BY CAMERA: Images can be photographically enlarged of the following procedures will allow you to create a film positive to meet your customer's specifications:

C) CREATING A POSITIVE BY HAND: Images can be photographically enlarge or reduced on clear acetate.

METHOD 1 Rubbing dry transfer lettering (Tec-type, Letraset, Geotype, etc.) onto clear acetate (Transtay). You will need: a roll or box of clear acetate (Transtay), an assortment of Tec-type lettering, and a burnisher for rubbing down letters.

METHOD 2 Tracing the image onto matte acetate using black ink and a technical pen or brush. You will need a roll of matte acetate, at least one technical pen, preferably an assortment of point sit a bottle of black ink and a small touch up brush.

METHOD 3 Cutting the image out of masking film, using a knife. You will need a roll of Amber of Rub Automask film; at least one knife, with replacement blades; a roll of gloss blackout tape for corrections.

METHOD 4 Using a copier machine to copy/enlarge/reduce your image onto Velum.

OTHER BASIC TOOLS AND SUPPLIES:

In setting up a work area specifically for artwork, include at each station a drawing table and a chair or stool at the correct height. A light table is ideal because it will allow the students to see their work more clearly.

layout guide
scissors
graph paper
lumocolor marker
ruler

proportion wheel
masking tape
register marks
magic tape

other possible needs
T-squares
triangles
French curves

circle templates
half-tone screens
stock art files
compasses, etc.

CREATING A POSITIVE BY HAND

METHOD 1:

RUBBING DRY TRANSFER LETTERING ONTO CLEAR ACETATE (TRANSTAY)

FOR STRAIGHT TYPE:

- 1) Tape a sheet of graph paper or the layout guide to the drawing using masking tape.
- 2) Tape a clear piece of acetate over the graph paper or layout guide.
- 3) Burnish (by rubbing the letters with a burnisher tool) the message directly onto the clear acetate, using one of the lines on the graph paper or layout guide as a guide.
Space the letters closely together for a neat and professional look.

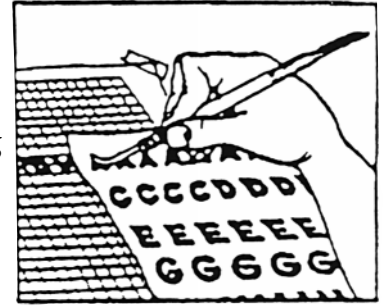

FOR ARCHED TYPE:

- 1) Tape the layout guide to the drawing table using masking tape.
- 2) Tape a clear piece of acetate over the layout guide.
- 3) Burnish the message directly onto the clear acetate, using one of the curves as a guide to align letters. Be sure to angle letters towards the centre.

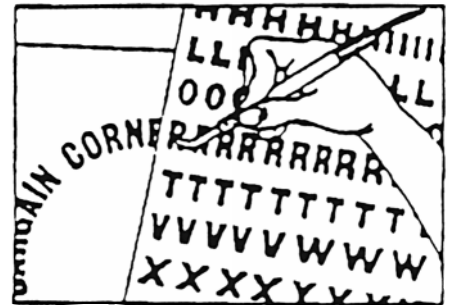

METHOD 2:

TRACING AN IMAGE ONTO MATTE ACETATE

- 1) Matte acetate is an acetate that has a matte finish on one side and a glossy finish on the other. Tape the acetate with the matte side up (this is the side you will draw on) over the image to be traced - your drawing or other image. (It is useful for tracing an image off a cap or jersey, or in some cases, tracing bad reproduction artwork). Of course, this method can be used to trace over lettering as well .
- 2) Using pen and ink trace over your image.
- 3) If this is to be a multi-colour print you must make as many pen and ink tracings as there are colours in the job.
- 4) Remember: When using matte acetate as a positive, you must ensure that the image be perfectly opaque. This means that you have to repeatedly ink over the image to ensure that completely no light is projected through. A less than opaque positive will yield a stencil that will not wash out completely and therefore you will have an unsatisfactory imprint.

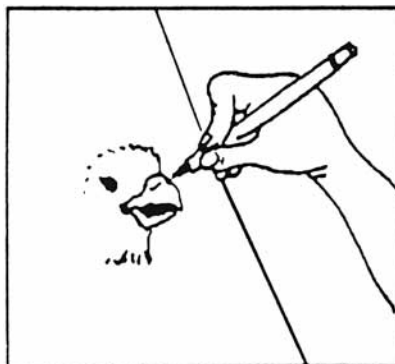

ASSEMBLING BASE ART

Putting together all parts of your artwork - images and message

After the different elements of the artwork have been completed (the burnished message and the line drawing), you must assemble or put together the artwork all together onto one acetate in order to have the positive for the stencil that you will be preparing in the next stage of the screen printing process.

Remember: These directions are for a one colour job (eg.black) and therefore you would require only one stencil. If your job has more than one colour, you need one stencil for each colour. In this case you would follow the directions for all multi-colour artwork to create more than one stencil.

- 1) Tape a layout guide to the table, then tape a clear piece of acetate to it.
- 2) Cut out all the type and illustrations using a knife, so that there is about 1/4" of space left around them. In order not to scratch the ink and letter surfaces, it is advisable to position all lettering and drawings face down on the acetate.
- 3) Now position the type message using the grid or layout guide to help you align, and secure in place with magic tape.
- 4) Position the drawing in the centre or off to the side, according to customer specifications, and secure in place with masking tape.



- 5) NEVER ALLOW ANY TAPE OR ACETATE TO OVERLAP A MESSAGE OR GRAPHIC. These overlapping lines will expose and show up in the final print.
- 6) You now have a completely ready to expose positive. You may want to apply registration marks and to cut subsequent colours.

METHOD 3:

CUTTING THE IMAGE OUT OF MASKING FILM

Masking film can be used for cutting out an image, such as a scripted team name, or for creating second and subsequent colour overlays on an existing positive.

When cutting an original image:

- 1) You are tracing the image's outline using a knife blade. Cutting masking film requires practice. You will want to cut the top film (orange or red), but not the bottom carrier sheet (clear).
- 2) After the image has been cut, the outside image must be stripped away, leaving you a complete, ready-to-expose positive.

When cutting a second or subsequent colour overlay:

- 1) You will need to tape down the original artwork (ie. a line drawing).
- 2) Cut the individual colours out of the masking film, cutting just into the outline of the design to allow easy overlapping of colours.

METHOD 4:

INSTANT POSITIVES WITH VELUM (DRAFTING PAPER)

Ideal for simple jobs! Fast and very economical! No expensive darkroom and processing chemicals!

- 1) Create your artwork in pen and paper, or use the computer to prepare the images and message, or copy a picture.
- 2) Now simply copy your artwork by running the velum through a laser printer* or photocopier* and create an instant positive.
- 3) Again, you must make one positive per colour used in your artwork.
- 4) The image created should be as opaque (black) as possible to block light during exposure. Use an opaquing pen or black marker to darken any areas, if necessary.
- 5) Place the positive image face up on the print side of the screen and expose using stencil method chosen. Screens will take slightly longer to expose (add about 20% to exposure time).

FOR ALL MULTI-COLOUR ARTWORK

As mentioned in the previous instructions for creating a positive, you must have one positive for each colour in the print job, regardless of how you have created the positives.

Three colours require 3 positives.

- 1) You must register the artwork overlays to one another so that the different colours will appear where they should. This is done using registration marks or targets.
- 2) With the base art (usually the darkest colour) taped onto the table surface, position one registration mark in the upper righthand corner and one in the lower lefthand corner.
- 3) Tape the next overlay, completely registered (in line) over the base art, and position new registration marks in the position over the first ones.
- 4) Continue with subsequent colours. You will end up having properly registered artwork that is easy to re-register should the positives become mixed up. The marks will also help the printer to register the screens more easily when printing.

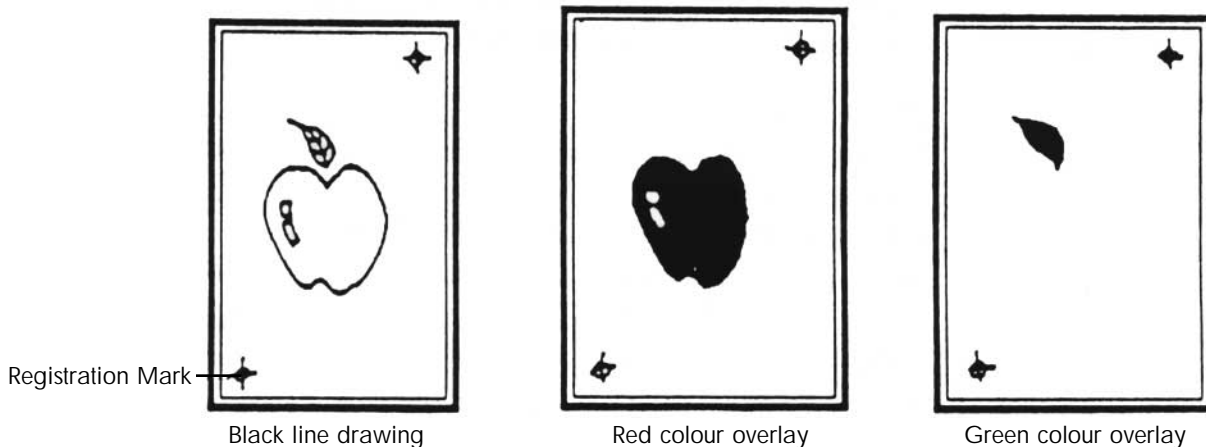

Three colour job requires three stencils.

LABELING ARTWORK

Remember to label the right bottom area of the positive(s) using lumocolor pen. Include the artist's name, number, and colour to be printed. The lumocolor pen is permanent but light enough not to expose onto the screen.

MESH PREPARATION

No matter what stencil system you choose, it is essential that the mesh material be prepared thoroughly to maximize stencil adhesion.

With a brand new screen, there are two steps that must be followed:

- 1) ROUGHENING with Autoprep
- 2) DEGREASING with Universal Mesh Prep

ROUGHENING THE MESH:

Meshes made of synthetic fibres are very smooth when first produced. Polyester is chemically inert, so most of the stencil's adhesion is physical. To increase this physical adhesion, the mesh must be roughened to increase the surface area available for adhesion.

For used mesh, it is a good idea to use this procedure every fifth use.

Procedure:

Use Autoprep, a grey paste containing an abrasive perfect for roughening the polyester mesh.

- 1) Simply wet the mesh thoroughly and apply Autoprep to the screen.
- 2) With a brush, scrub in circular motions, until the entire mesh is coated.
- 3) Allow to sit one to two minutes, and rinse both sides thoroughly with water.

A word of warning: NEVER use scouring powder to abrade screens! They contain very coarse particles that can get trapped in the fibres and destroy the mesh.

DEGREASING THE MESH:

New mesh tends to be greasy following its manufacture. Older meshes sometimes get greasy residues from inks or from being stored too long. Degreasing is necessary prior to putting the stencil on the mesh. A properly degreased mesh will hold water on it like a film. If not properly degreased, the water runs into rivulets and drains from the mesh quickly because the water is being repelled by the fibres.

It is advisable that a screen be degreased with every use before applying the stencil. Use Universal Mesh Prep, a light brown fluid for degreasing and improving the wetting-up characteristics of mesh.

Procedure:

- 1) Rinse the screen thoroughly with water.
- 2) Apply Mesh Prep using a rag (not paper towels) to both sides of the mesh and rub in with a brush, rag, or glove using circular motions.
- 3) Leave on one to two minutes and rinse off with a strong spray of water.

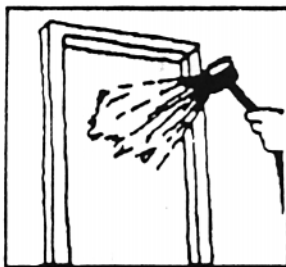

Wet down Screen



Work in with a brush

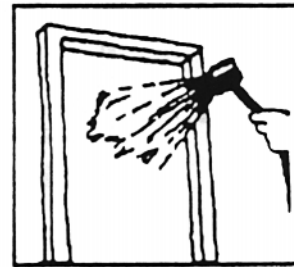

Rinse Screen Thoroughly

REMEMBER: The importance of thorough mesh preparation can never be emphasized enough. It should be looked upon as one of the basic ground rules when producing stencils.

Failure to pre-treat mesh can lead to costly breakdowns in production, which can easily be eliminated by taking a few extra and inexpensive minutes at the beginning of production to roughen and degrease the mesh.

PREPARING THE STENCIL

USING CAPILLARY FILM

Capillary films, or Autotype Capillex films are direct photostencil films.

This is an easy, quick, and fool-proof method of preparing your stencil. It is excellent for T-shirts with fine detail, as well as decals.

- 1) In safe light or in subdued artificial light, cut the film size required (larger than artwork) for the job. Return remaining film immediately to the original tube or box and seal in plastic.
- 2) Thoroughly wet both sides of the prepared mesh.
- 3) Check to be sure the film is dust-free, and apply the dull side of the film to the underside or print side of the screen.
- 4) With a light spray (a window cleaner bottle is ideal) soak all "white" spots with water. These spots indicate where the film has not adhered.
- 5) Using a clean squeegee, gently scrape off (Do Not Rub) excess water using a light even stroke, from the SQUEEGEE SIDE OF THE SCREEN. Blot (Do Not Rub) excess water on the underside of the screen with unprinted newsprint.
- 6) Allow screen to dry horizontally in safe-light area with underside (print side) of screen facing up. A fan will speed up drying time. Do not use heat to dry the film. It will cause damage and be impossible to expose.
- 7) When completely dry, remove polyester (clear) backing sheet before exposing. The clear backing sheet is easy to remove from dry film. If it seems difficult, increase the drying time.

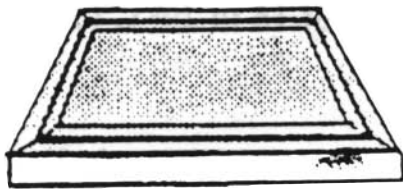

underside or print side

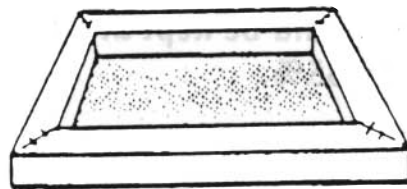

squeegee side

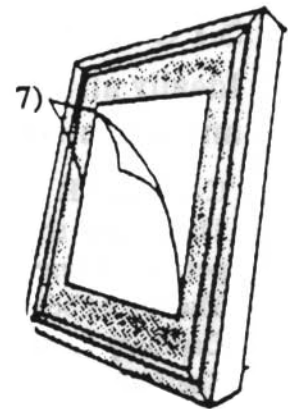

USING DIRECT EMULSIONS

Duracoat, Resistal, Autosol Fast, and Autosol Plus Clear are direct emulsions.

This method is quite a bit cheaper than using the capillex film, but is not as fast and easy. All emulsions are supplied as two-piece kit consisting of an emulsion base (large container) and a diazo sensitizer (small container).

A) MIXING THE EMULSION

- 1) Fill the sensitizer bottle 4/5 full with warm water and shake until the sensitizer is fully and completely dissolved.
- 2) Pour the sensitizer solution into the emulsion base and stir in thoroughly with a plastic or wooden stirrer until you see no more streaks. The emulsion is now light sensitive.
- 3) Allow it to sit, tightly covered in a dark place, for at least 1/2 hour once sensitized, to allow air bubbles to escape.
- 4) The emulsion is now ready for coating onto a screen. Once mixed it will last about 3 months, longer in the fridge, but keep it tightly covered and out of light.

B) COATING THE EMULSION ONTO A SCREEN:

- 1) Pour a quantity for emulsion into the scoop coater, enough so that the emulsion is easily distributed across the width of the scoop coater. Any leftovers can be poured back into the original container and stored in a dark place.
- 2) Stand the screen on edge tilted slightly away from you and starting on the squeegee side, coat the screen with a thin edge of the emulsion. Hold the coater consistently and move in a smooth motion, being careful not to nick the edges.
- 3) Follow the same procedure and coat the print side of the screen.
- 4) Finish with a final coat on the squeegee side. If emulsion coating seems uneven, then use a "dry scrap" on the squeegee side and reapply. Always finish with a coat on the squeegee side.
- 5) The screen should be dried HORIZONTALLY and stored in safe-light or yellow light conditions.
Dry at a maximum temperature of 30°C (86°F).
Never use a blow dryer or other heat source to speed up drying.
- 6) The scoop coater must be washed with warm water immediately after coating screens.
Screen Strip will remove any emulsion that has dried on.
Care should always be taken not to nick or gouge the blade of the coater.

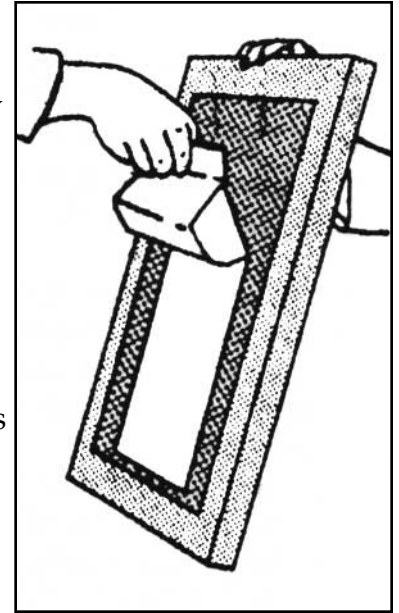

STORAGE AND HANDLING OF STENCIL MATERIALS

Ideally all stencil materials should be kept at a temperature of 15 to 20°C (59-69°F) and a relative humidity of 55-65%.

CAPILLARY FILMS:

These films should be handled under low wattage yellow light or subdued artificial light only for short periods of time.

The roll or box of film should be kept closed and sealed after use.

Capillary films can be kept at room temperature in their own container with the lid sealed.

Shelf life is 12 to 18 months from the date of manufacture.

Screens coated with capillary film and stored in a safe light area will have a shelf life of up to three months.

DIRECT EMULSIONS:

Emulsions should never be exposed to a temperature of 0°C, or the freezing point.

Unsensitized emulsions have a shelf life of 36 months from date of manufacture.

Sensitized emulsions can be stored in their own containers for three months.

If stored in a domestic refrigerator, this time can be doubled.

Screens coated with direct emulsions and stored in a safe light area will last six weeks to three months.

Note:

For a fault finding guide to determine problems, causes and solutions for stencil and prints, see page 21-22

EXPOSING THE STENCIL

POSITIONING THE ARTWORK: SIZE AND PLACEMENT OF IMAGE ON SUBSTRATE

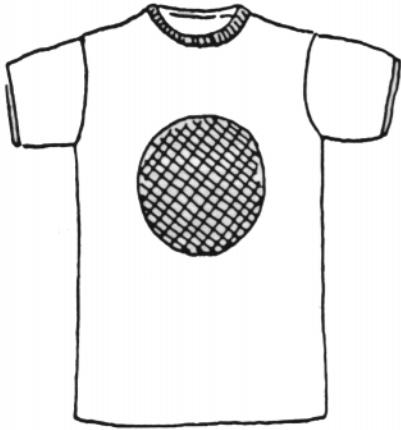

ADULTS
approximately 10" diameter

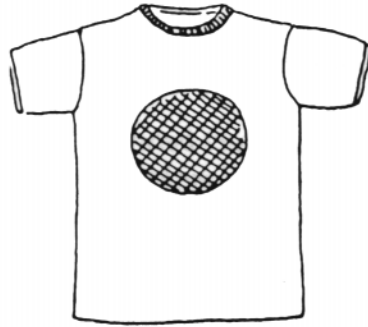

CHILDREN
approximately 8" diameter



Design should not be larger than 4" x 5" and should line up at the bottom of the armpit and be centered between the center of the shirt and the sleeve. Women's and Children's may be slightly higher

POSITIONING THE ARTWORK ON THE SCREEN:

- 1) Place the positive face down onto the platen (form that holds T-shirt) in the exact area where it will be printed on the garment.
- 2) Place Magic Tape on the corners of the positive, facing upwards. If you turn in a corner edge of the tape first, it will be easier to grab the edges when you want to untape.
- 3) Take a pre-coated screen, place it in the head of the printer and lower the screen down to the platen so that it is in contact with the positive and the tape. Press the taped areas so that the positive will adhere to the underside of the screen.
- 4) Remove the screen from the head of the printer and expose, following directions for your particular exposing unit.
- 5) In the case of a multi-colour design, repeat steps 1 through 4 will all colour positives.

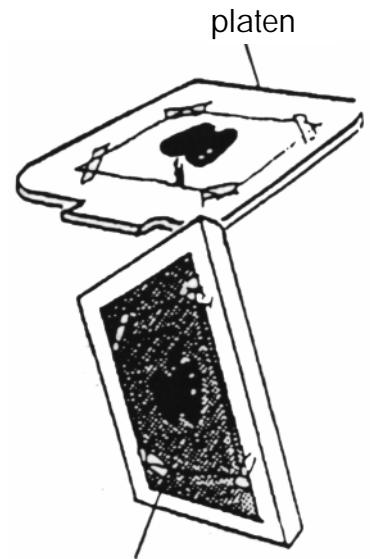

positive face up on underside of screen

After positioning the artwork on the pre-coated screen, you will use an ultra-violet light source to expose it (unless you are using a handcut stencil film). You must make certain that there is excellent contact between the positive and the stencil, ie. that the two are as close to each other as possible.

EXPOSING UNITS

TABLE TOP EXPOSING UNIT

Ideal for schools or small shops!
All the features of the larger unit
But compact and economical.

Features:

- High quality live rubber vacuum blanket
- Dimensions: glass surface 27" x 31"
- Powerful vacuum pump to ensure tight contact between screen and positive for perfect screen stencil making.
- High efficiency, ultra-violet light tubes for perfect exposure.



BUILDING AN EXPOSING UNIT:

Two types of simple exposing units may be built with materials you already have on hand, or can easily purchase. One uses fluorescent tubes, the other a 150 watt plant light. These are inferior, but may be sufficient for the task on hand.

A) THE FLUORESCENT TUBE UNIT

You will need four double fluorescent fixtures (2 or 4 feet long), and enclose them in a wooden or metal box. Place a sheet of 1/4" / 6mm glass over the top, leaving two inches between the bulbs and the glass.

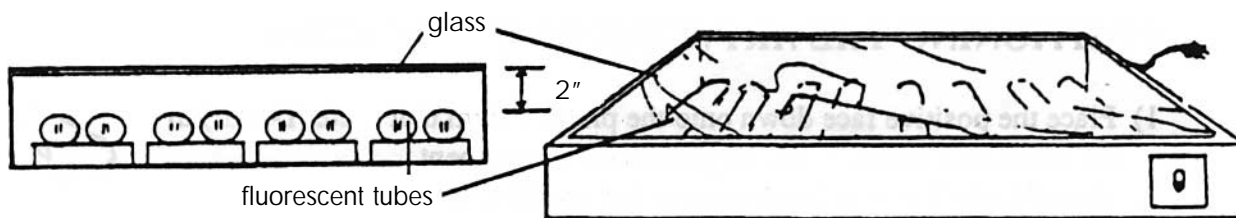

TO EXPOSE:

- 1) Place the screen underside or print side down on the glass of the exposing unit.
- 2) Weigh the screen down with a cloth-covered piece of plywood, cut slightly smaller than the inside of the screen (or use a book). Place two bricks or weights on top to ensure proper contact. It is essential that contact be as tight as possible, or the result may be loss of fine detail, as well as make washing out more difficult.
- 3) With the fluorescent tube we recommend an exposing time of five minutes as a first test.

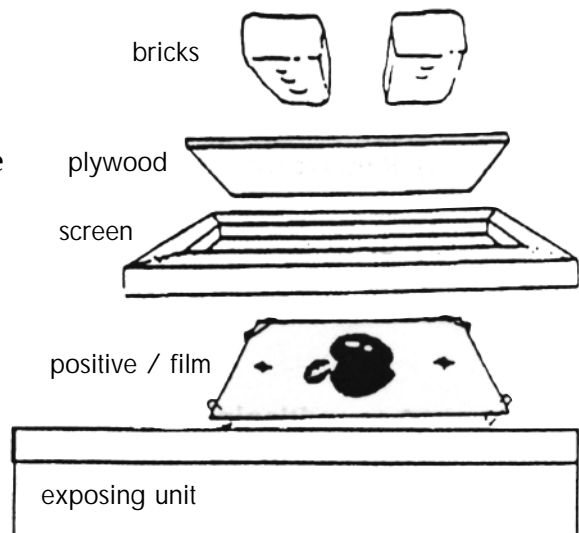

THE PLATE LIGHT

A very effective and economical way to expose a screen using a regular 150 watt plant bulb. This avoids the costly investment of a vacuum exposing unit or building a complex light table. This method is ideal for screens that are less than 20"x24" OD.

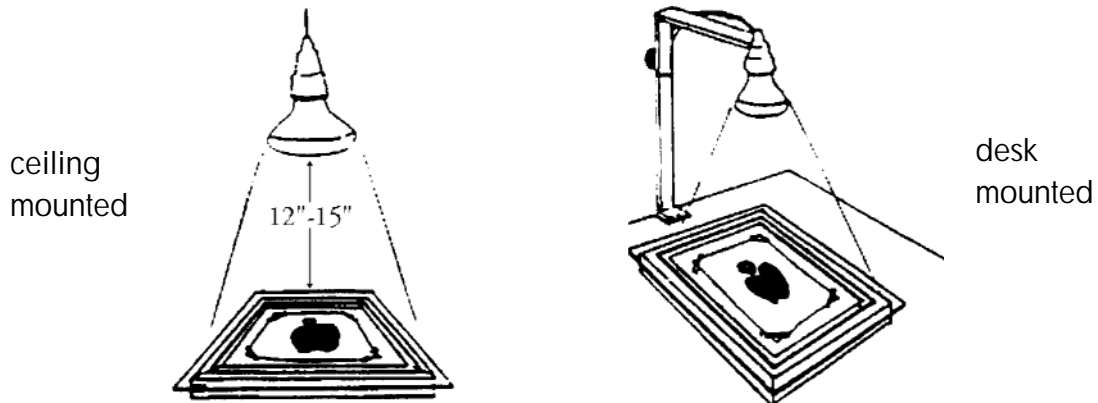

TO EXPOSE

- 1) Tape the film positive to the screen side (outside).
- 2) Place the styrofoam block on squeegee side (inside).
- 3) Position the screen with the foam on a table, positive side up and place the sheet of glass on top of the screen. This secures the film and ensures proper contact with the screen.
- 4) Expose for 25 minutes at 12-15" distance from the screen.
- 5) Immediately after the screen is exposed, remove the positive and spray the print side of the emulsion with water until the unexposed areas are completely clear.
- 7) Blot with unprinted newsprint and dry horizontally.
- 8) Once fully dry, place screen against a window or in front of a light source and check stencil for pinholes. Using a small brush, patch up with unused emulsion.
- 9) Once emulsion is dry, the screen is ready to use.

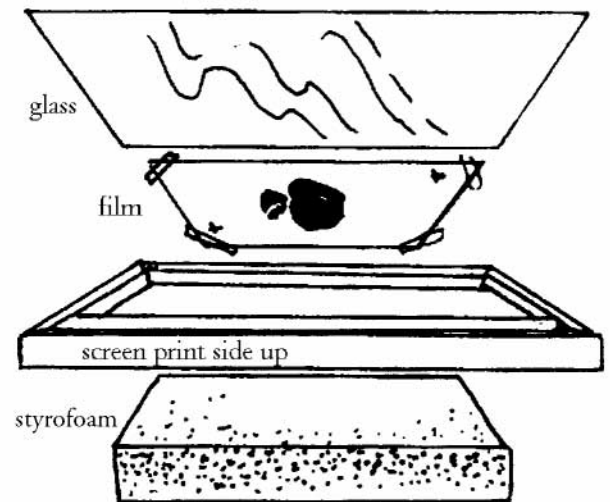

EXPOSURE TIMES OF DIFFERENT STENCIL MATERIALS

The following times are approximated for use with the Exposing Unit (UV Black Light)

Capillex Films

Capillex 25	4 1/2 minutes
Capillex 35	5 minutes
Capillex 50	5 1/4 minutes
Capillex XR40	6 minutes
Capillex XR80	8 minutes

Velum

Generally add 20% to exposure times

DIRECT EMULSIONS

Duracoat	74-86 mesh	4 minutes
	110-160 mesh	3 minutes 15 sec.
	200-230 mesh	1 minute
	255-305 mesh	50 seconds
Autosol Fast	74-86 mesh	4 minutes
	110-160 mesh	3 minutes 20 sec.
	200-230 mesh	2 minutes 30 sec
	255-305 mesh	2 minutes

PREPARING THE SCREEN FOR PRINTING

A) WASHING OUT THE STENCIL

- 1) After the screen is exposed, remove the positive.
- 2) Rinse the print side of the emulsion, then the squeegee side, and allow to soak for 30-60 seconds.
- 3) Proceed with washing out unexposed areas until they are completely clear, alternating from side to side of the screen.
- 4) Blot screen and stencil with unprinted newsprint (never paper towels) and **ALWAYS DRY THE SCREEN HORIZONTALLY.**

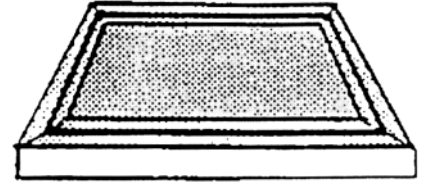

B) BLOCKING OUT PINHOLES

- 1) Once the screen is dry, check the stencil for pinholes, using a light source such as a light table.
- 2) With a small paintbrush, dot filler over any pinholes on the PRINT SIDE of the screen.
- 3) Smooth the filler with your finger to ensure that it will not leave a lump when it dries. You do not want any lumps that will nick your squeegee.

NOTE: Use filler appropriate to the ink system you will be printing with. XR Filler must be used with water-based inks; regular filler is fine for use with plastisols and solvent-based inks.

If any filler happens to get on the image of your stencil, quickly wipe off with a damp cloth. (Do not use saliva as there will be a reaction with the enzymes in it).

Be sure to wash brush after use.

C) TAPING THE SCREEN

- 1) Once all pinholes have been filled and the filler is dry, proceed to mask out the perimeter of the screen with Screen Prep Tape. This is done on the SQUEEGEE SIDE (makes clean-up easier as the soiled area will be small). Leave about 2 inches clear around the image and registration marks. Tape the sides of the screen as well to ease clean-up of screen.

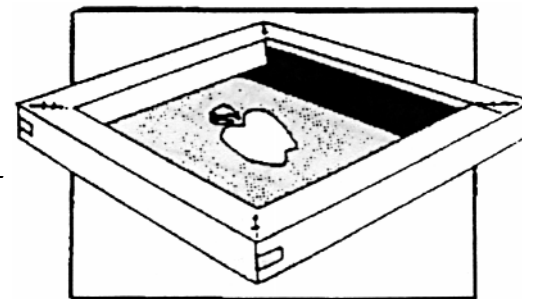

- 2) Later, as you are setting up for printing and have registered your screen, you can tape over the registration marks and around the image with Duratape, a bright blue, very resistant tape. This will prevent any ink from seeping under the screen and under the tape, and will ease clean-up of your screen. Be sure tape is smooth, no bumps.

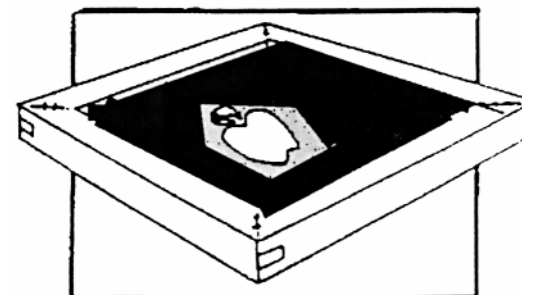

PRINTERS

Printing involves the depositing of ink onto the screen and then passing the ink through the mesh left open by the positive onto the substrate(item to be printed below).

TABLE TOP 4 COLOUR PRINTER

Ideal for schools or small shops with limited space!
An efficient, low-cost alternative to larger floor models.

Features:

- 4 color, 1 station
- Forward adjusting side clamps
- Adjustable platen arm
- Industrial strength bearings
- Positive location "stop"
- Accepts screens up to 19" x 23" (outside)

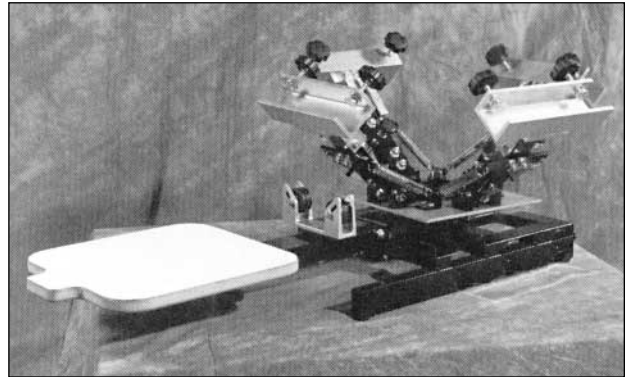

PRINTING ON A TABLE SURFACE:

This method involves using our hinge clamps to hold the screen onto a routed surface. This is a primitive method with the disadvantages of lacking the speed, ease, precision, and productivity of an actual printer.

- 1) The printing surface should be smooth and hard. Arborite or other laminate would be ideal, and easy to clean.
- 2) The table should be routed as shown so that the frame of the screen lies flat on the table.
- 3) Bolt the hinge clamps down into the round area of the table, place the screen in the clamps and tighten.
- 4) Use spray adhesive on the table to hold the paper to T-shirt in position and wrinkle-free. Just spray lightly, allow to dry for about 30 seconds and position the substrate.

OFF-CONTACT PRINTING

To prevent smearing, build up the edges of the frame so that the screen does not make contact with the substrate until the squeegee is pulled across. You can use cardboard or very thin pieces of wood (usually no thicker than 1/8").

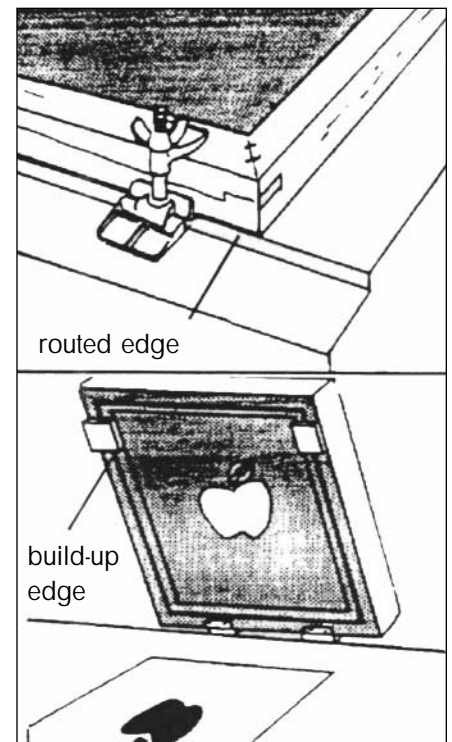

PRINTING

- 1) Spray adhesive to the surface or platen that the substrate will be positioned on, and then position the substrate. If the substrate starts to lift, spray more.
- 2) Select a squeegee. Check the technical data for the ink used to determine the correct squeegee durometer. Water-based inks usually require a 60 durometer. Tape the upper edges of the squeegee blade to ease in clean-up later.
- 3) Register the screens and place in position over the substrate. Each colour must fall into its correct position and alignment in relation to the others, and the registration marks you have made will indicate this position. Once you have registered the screens, you tape up the registration marks so they will not print through when the ink is applied.
- 4) With the screen lifted off-contact, add ink to the screen, away from the image.
- 5) With the screen still off-contact, flood the ink across the entire image area. This stroke requires very little pressure, not much more than the weight of the squeegee itself. This step is especially important with air-drying inks to prevent them from drying in the screen.
- 6) Lower the screen onto the substrate, and applying slightly more pressure, clear the ink away from the image area by bringing the squeegee towards you. Keep the squeegee almost vertical. This forces the ink through the openings in the mesh through to the substrate. More than one pass may be necessary to make a satisfactory print, depending on the ink and the substrate used.
- 7) Continue printing, establishing a rhythm of flooding and printing. If you have a 4 color printer, it holds 4 screens. You simply swing the next screen around over to your station which holds your substrate, and it automatically will register into the right position to print your next color.

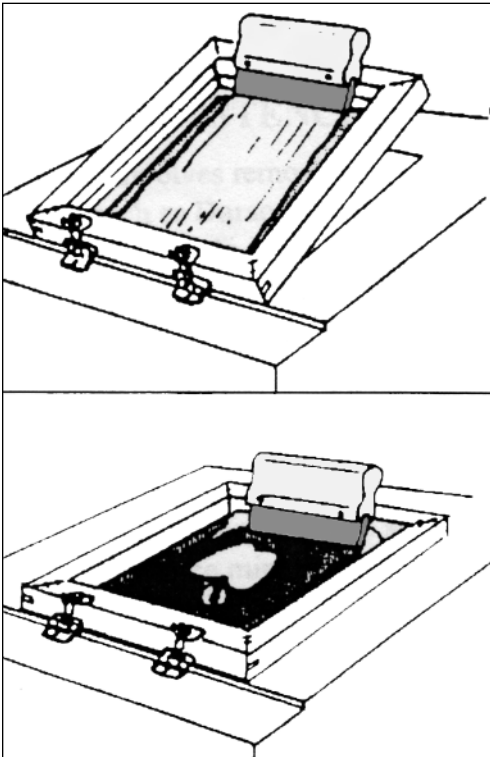

8) After printing, scoop up all excess ink with a piece of cardboard and return it to the can (except when using ink/catalyst mixtures, as these have a limited shelf life).

9) Remove all the tape and proceed with reclaimed the screen. The screen should be cleaned as soon as possible as the inks will harden and be more difficult to remove.

FLOOD STROKE

Flooding ink across the entire image area before every print is necessary to stop air-drying inks from drying in the screen. This is done with the screen raised.

PRINT STROKE

The screen is lowered, but is not actually touching the substrate (off-contact) because the edges have been slightly built up. The print stroke requires slightly firmer pressure on the squeegee than the flood stroke, to push the ink through the open mesh to the substrate. As the squeegee passes over the screen moves down and then lifts, and is again off-contact.

STENCIL REMOVAL/SCREEN RECLAIMING

RECLAIMING A SCREEN:

The same screen can be used many times for different print jobs.

Thorough removal of stencil material (inks, etc.) ensures that no residues are left on the screen which could impair subsequent adhesion of the next stencil, and effect future print quality.

Follow these steps for reclaiming a screen:

1) REMOVING TAPE AND INK

After you have removed all the tape and excess ink from the screen, you will need to clean the ink residues off the stencil. A few examples of different wash-ups are:

Water: For water based inks: following by 2000 Green for any difficult to remove ink remaining especially if it has dried in the screen.

2000 Green: A biodegradable cleaner made from nature's own ingredients.

A safe and environmentally friendly wash-up for both plastisol and water based inks.

Cleans up adhesives easily (great for T-shirt pallets)! Wipes clean with a damp cloth.

Removes tar, grease, grime as well as many other inks and paints.

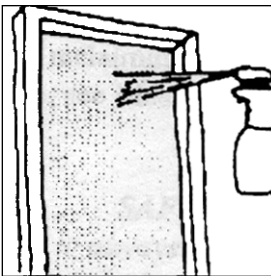

Apply 2000 Green with spray bottle

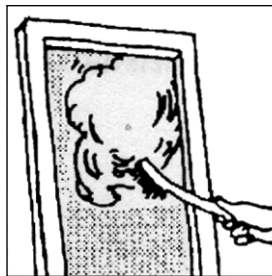

Work in with a brush or sponge

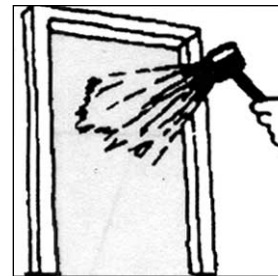

Wash away with water

Mineral Spirits: For plastisols. More toxic, less environmentally friendly and safe than 2000 Green.

2) REMOVING STENCIL MATERIAL

The next step involves removing all traces of stencil material.

For stencils such as Duracoat and Autosol emulsions, Capillex films, Novastar and Autocut Amber, you would use Screen Strip.

SCREEN STRIP: This powder mixes with water, in the usual proportion of 100g to 10 litres of water, depending on the water-resistancy of the stencil. Duracoat, Autosol Fast, Autosol Plus Clear, Capillex XR will need a more concentrated solution of perhaps 100g to 5 litres of water.

Procedure:

Apply a small amount to both sides of the screen with a soft brush or cloth.

After two to three minutes, the emulsion coating will have dissolved and the mesh can be washed with a strong spray of water. NEVER ALLOW SCREEN STRIP TO DRY IN THE SCREEN.

3) REMOVING STAINS OR GHOST IMAGES WITH AUTOHAZE

When the stencil has been removed, ink hazes or ghost images may still be apparent. These should be removed if they block the meshes when held up to the light. For this purpose, use Autohaze, an alkaline paste that provides a highly effective method of removing stubborn stains and the hardest residues of emulsion or ink from polyester meshes.

Procedure:

Apply Autohaze to both sides of a wet mesh with a brush.

Cover the stained areas in a circular motion.

Leave on the screen for 6 to 8 minutes. If left longer, the mesh could be damaged and start to rip.

Rinse off with a gentle spray of water, followed by a stronger spray.

4) ROUGHENING THE MESH WITH AUTOPREP

It is necessary to roughen the mesh with Autoprep periodically, usually every fifth or sixth stencil. You may want to use Autoprep more frequently when utilizing Capillex films.

5) DEGREASING THE MESH WITH UNIVERSAL MESH PREP

The last and very necessary step to Screen Reclaiming. Always finish reclaiming with an application of Universal Mesh Prep.

Safety First!

Remember to always wear gloves, goggles, a particle mask and a protective smock or overcoat during stencil removal procedure to protect skin, lungs and eyes.

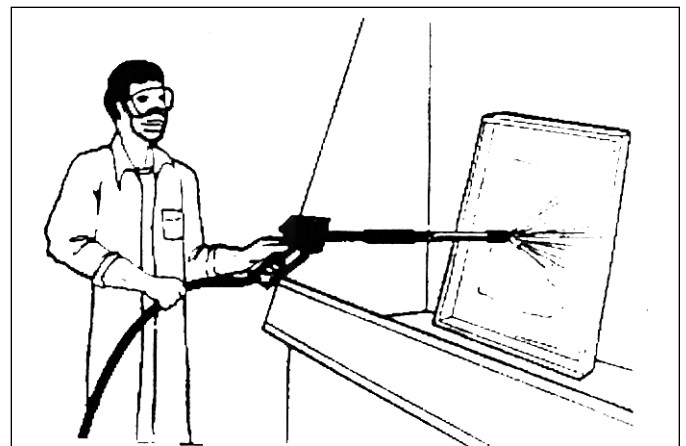

REVIEW - SCREEN RECLAIMING

- 1) Use 2000 GREEN to remove plastisol residues and difficult spots of Aquatex.
- 2) Use Screen Strip to remove stencil material.
- 3) Use Autohaze to remove ghost images if apparent.
- 4) Use Autoprep if necessary (fifth or sixth use of screen).
- 5) Use Universal Mesh Prep every time for degreasing.

FAULT FINDING GUIDE

If your stencil or image print out appears to be of inferior quality, check the following fault finding chart to help you determine what went wrong and how to correct the problem.

CAPILLEX FILMS

Stencil film washes off mesh

- under exposed
- poor degreasing
- insufficiently roughened mesh
- film applied to too fine a mesh

Ragged edges

- Capillex applied to too coarse a mesh
- under exposed

Fine detail filling in

- over exposed
- poor contact between positive and stencil film during exposure
- film dried with excessive heat
- Stencil stored too long before exposure
- positive not opaque enough

Pinholes

- dust between glass/positive/stencil
- dust trapped between stencil film and mesh during laminating

Poor adhesion

- under exposed
- poor degreasing
- insufficient roughening of mesh

Patchy stencil

- poor mounting technique
- excessive time lapse between squeegeeing off excess water
- film laminated on uneven surface

Difficult washout

- over exposed
- film dried using excessive heat
- positive not opaque enough

DIRECT EMULSIONS

Sawtoothing

- mesh too coarse, finer detail requires fine mesh
- incorrect washout, do not use excessive spray

Exposed emulsion washes off mesh

- under exposure
- not enough sensitizer or poor dispersion in the emulsion
- insufficiently roughened or degreased mesh

Fine detail filling in

- over exposed
- uneven coating of emulsion
- uneven contact between positive and emulsion
- positive not opaque enough

Premature stencil breakdown

- mesh not stretched tightly enough
- under exposed, emulsion not fully hardened

Pinholes

- dust on glass or positive
- contamination in emulsion: work in clean area and replace lid on emulsion when not in use
- stencil washout carried out for too long or use of too strong washout pressure

Scumming

- poor washout: ensure that the image is totally cleared
- inadequate blotting out after washout
- screen allowed to stand vertically when just washed out: dry horizontally

Image does not wash out at all

- excessive over exposure
- coated screen dried in excessive heat (max. 30°C or 86°F)
- coated life of screen expired: do not store more than 3 months at room temperature



Single System

The Paro Single is a special paper that you can photocopy images onto. After the image is applied to the paper, it can then be ironed onto most smooth finished fabrics. The fabrics can be natural or blends. It works best on white or light coloured fabric due to the transparent nature of the image. Does not work on black fabric! Parosingle is an ideal alternative for printing images onto fabric where multiple colours are required.

COPIER OUTPUT

Place PAROsingle in copier tray, positioned to copy onto the blank side. Align original on copier platen and press COPY or output via computer interface to copier. Use *Mirror Image function to ensure a right reading image*. NOTE: To produce a more accurate image, decrease toner levels and/or lighten exposure level. With white backgrounds, use the background elimination function or designate no-colour in the colour creation mode. The best machines to run on, are Canon 300/500/700/800 series colour copiers. For all others brands (Xerox, Ricoh, Kodak), please test performance first.

HOW TO TRANSFER USING A HAND IRON

Pre-heat iron on low 'cotton' setting. Do not use steam. Place transfer image side DOWN on the fabric. Press iron firmly in one area for 10 - 15 seconds. Move slowly around to another area and repeat till whole image has been covered. Use two hands and body pressure when pressing to achieve maximum pressure. Immediately reheat entire surface with iron, being certain to cover all edges and corners. Peel transfer from garment while HOT. If you are using a heat press, press at 350-375°F for 10-12 seconds and peel immediately.

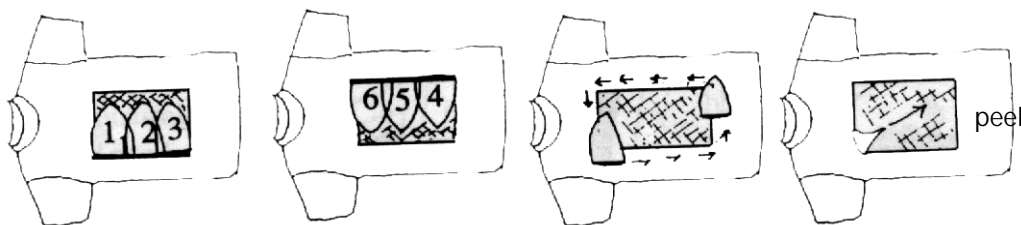

WASHING INSTRUCTIONS

Turn garment inside-out and machine wash in cool or warm water. Do not use bleach or fabric softener. Warm tumble dry. Iron at medium setting. Do not dry clean.